

PLAN
SCALE: 1:8

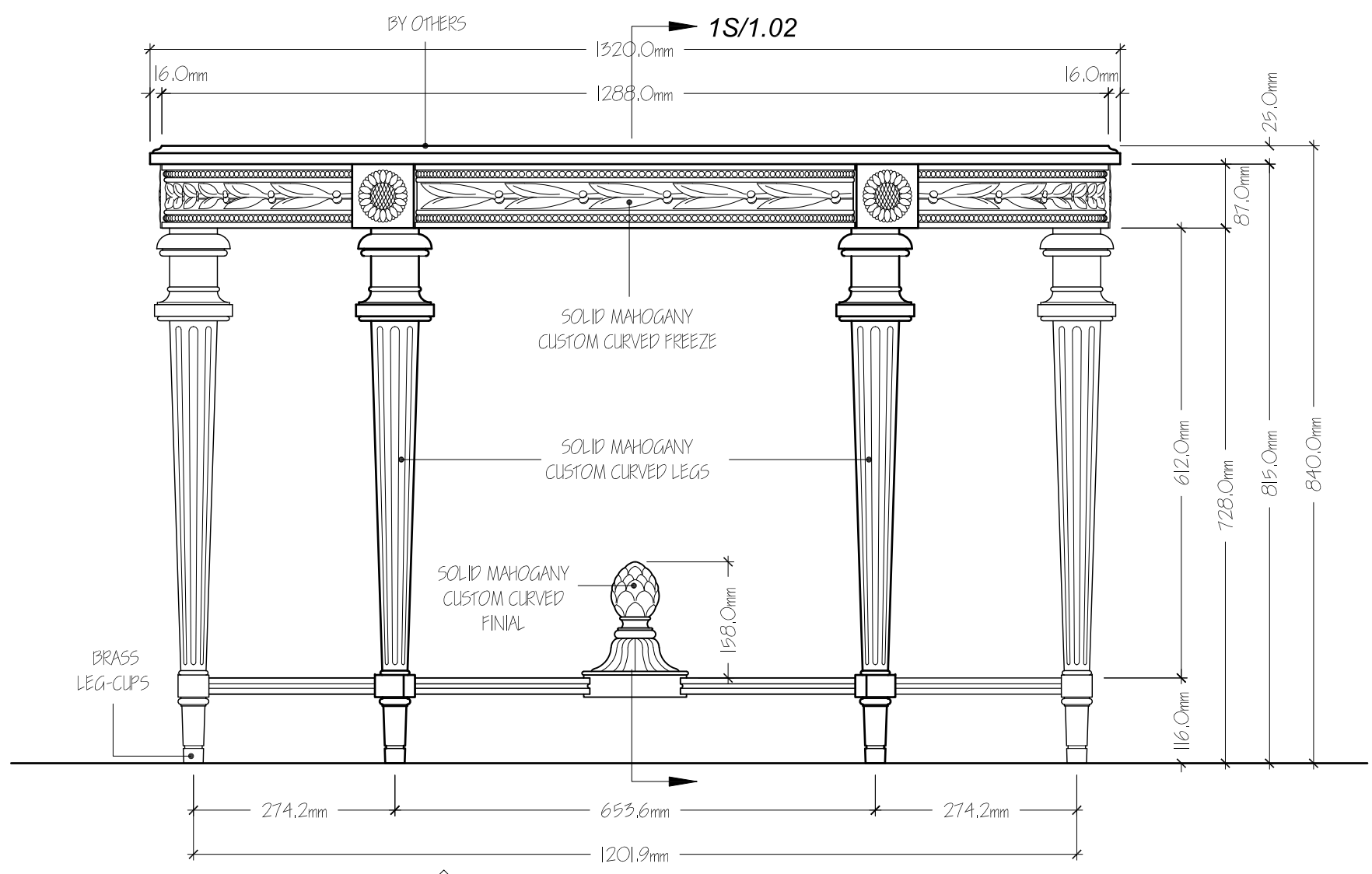

ELEVATION
SCALE: 1:8

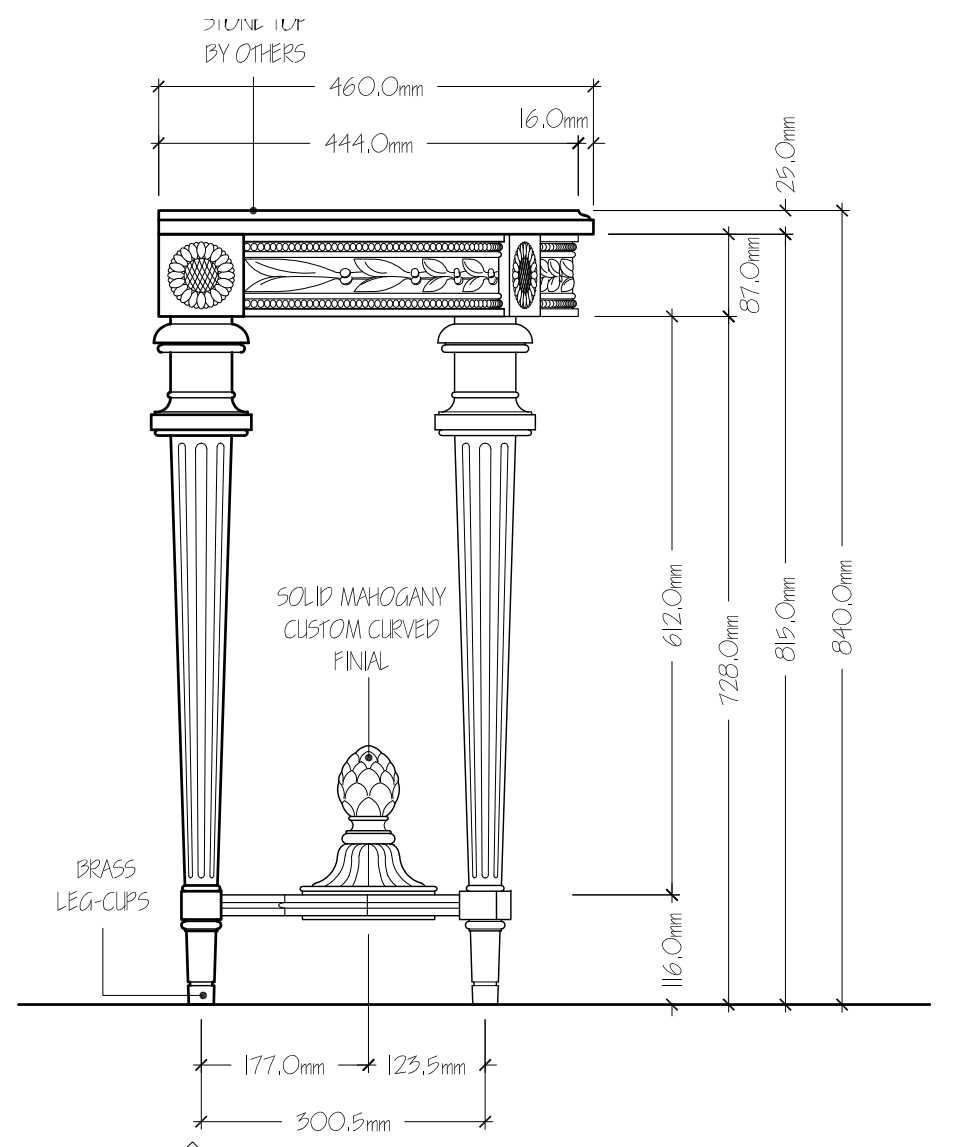

ELEVATION
SCALE: 1:8

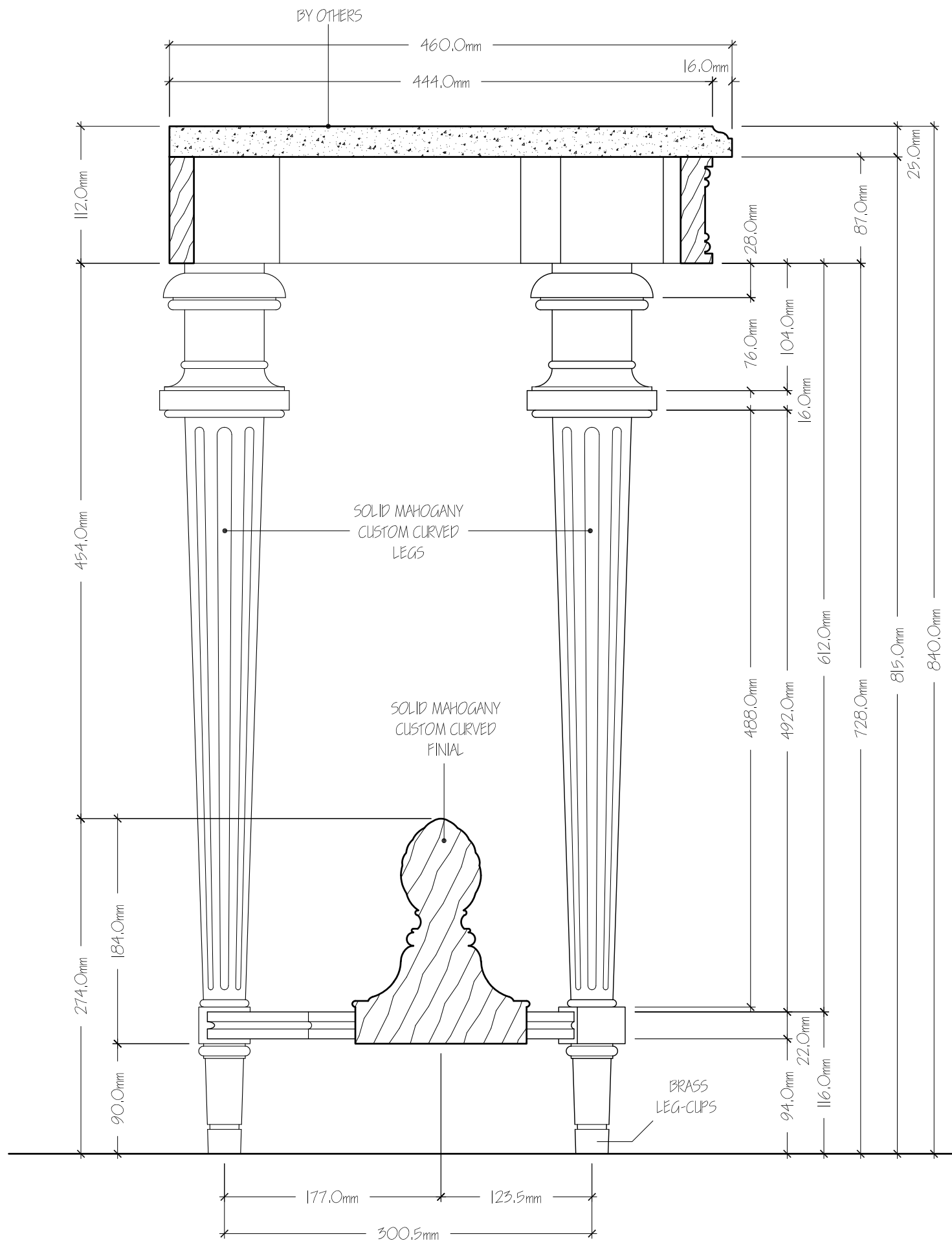

1S

SECTION
SCALE: 1:4

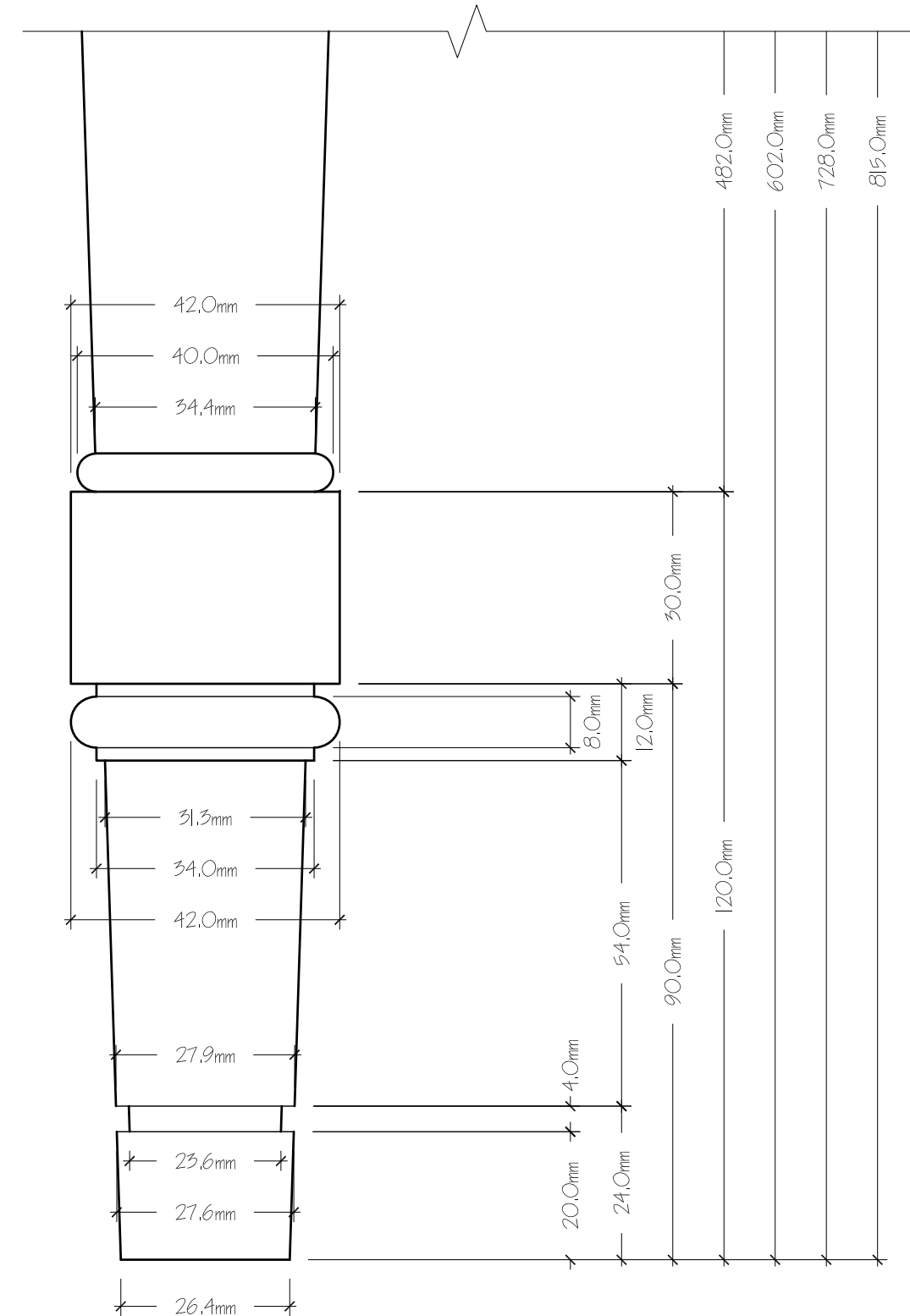

DETAILS @ LEG END
SCALE: FULL

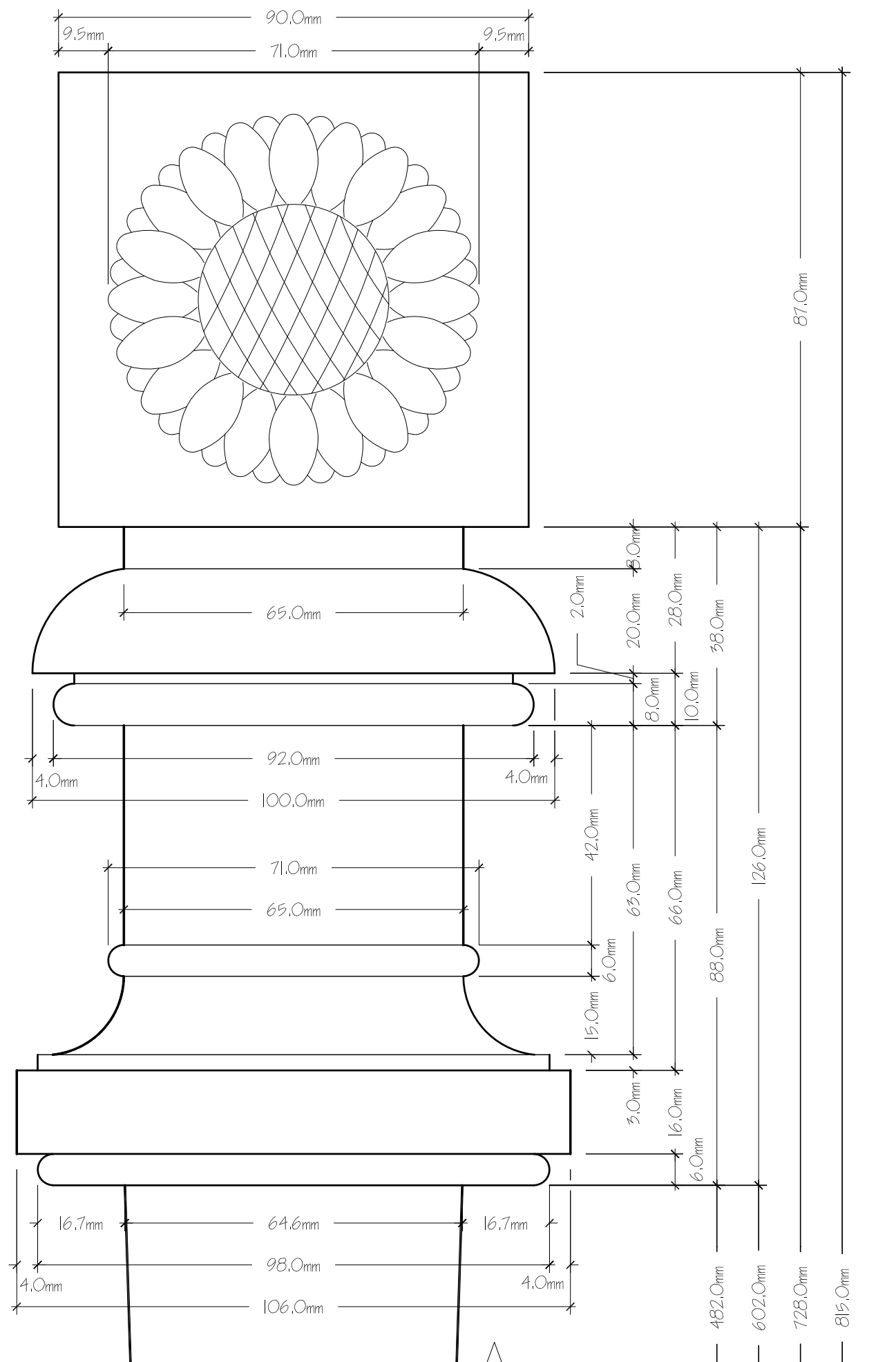

DETAILS @ ROSETTE
SCALE: FULL

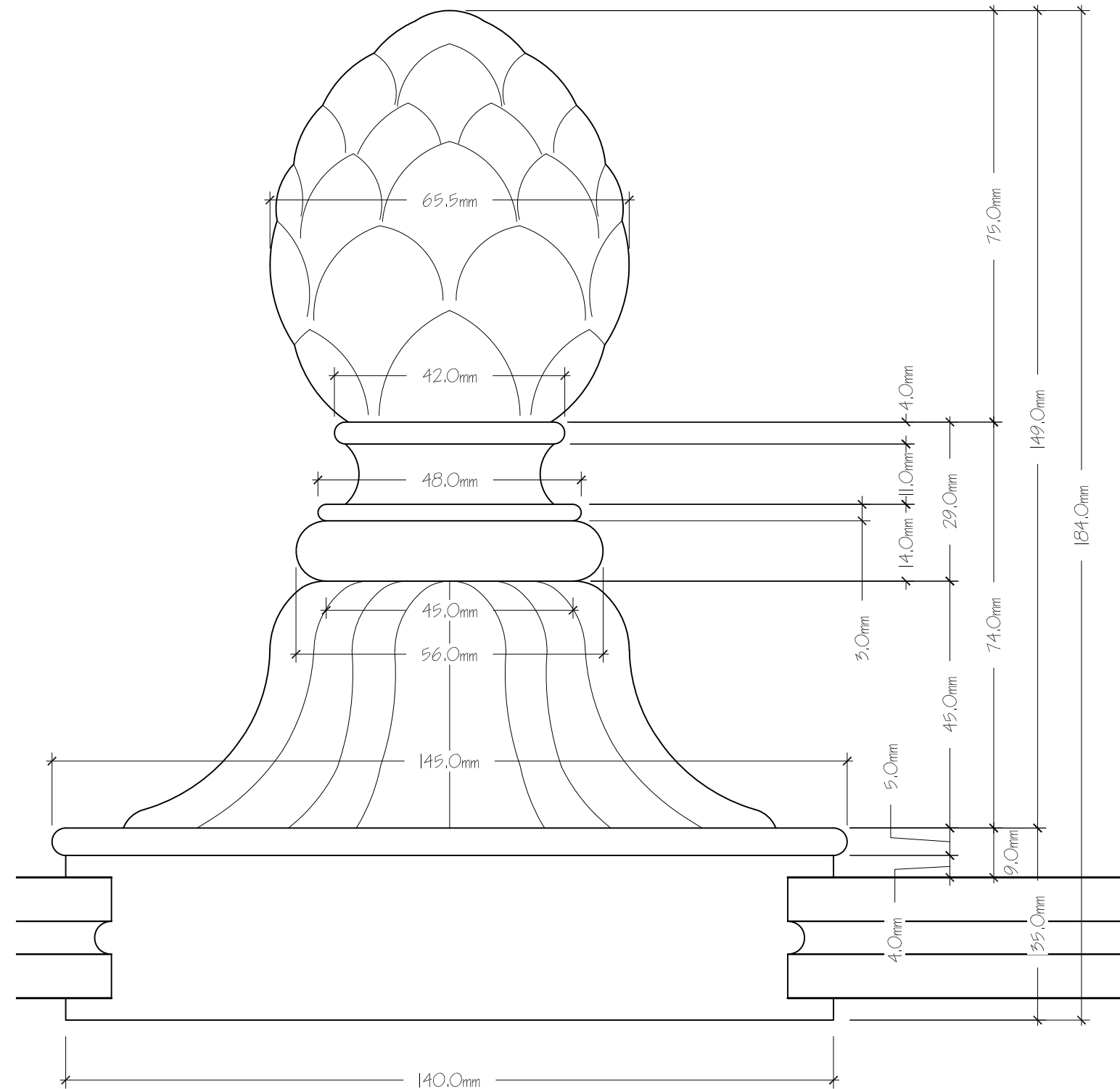

DETAILS @ FINIAL
SCALE: FULL

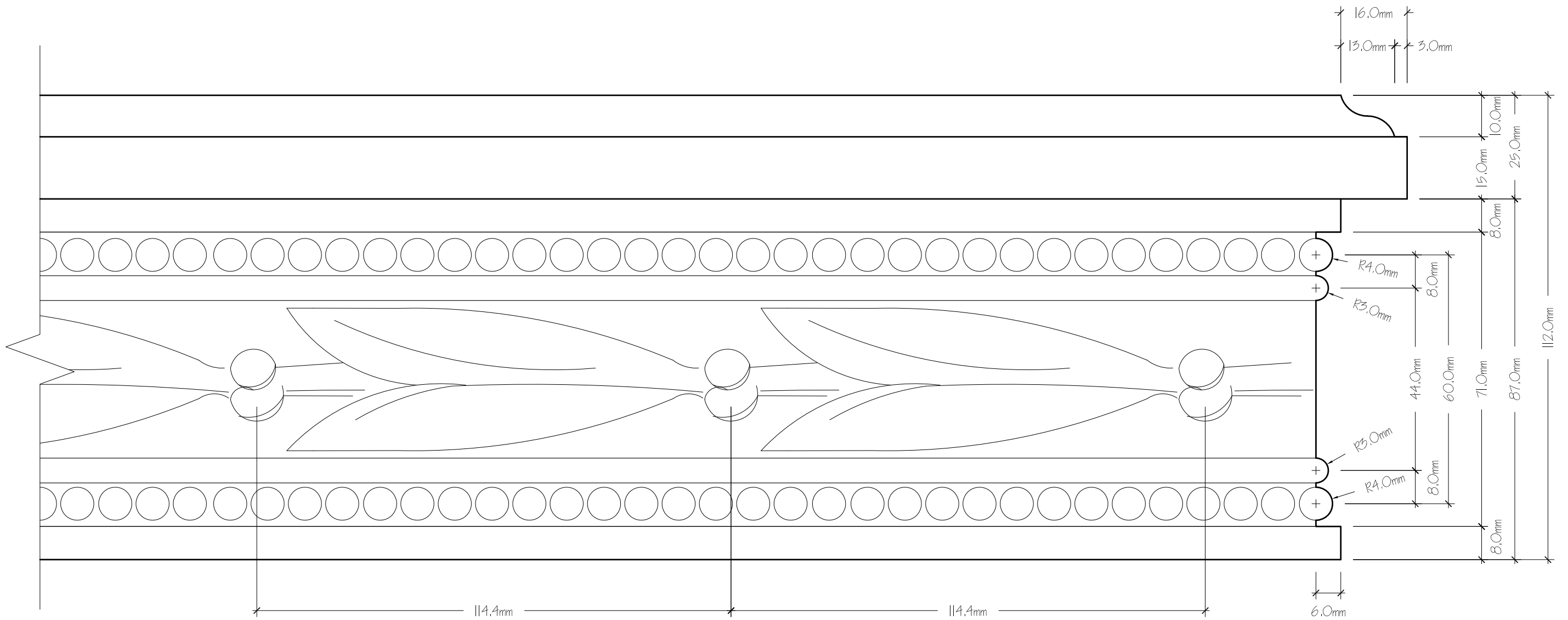

DETAILS @ FREEZE
SCALE: FULL

Drafting & Design

By Mikhail

07 / 02 / 2014

PRIVATE RESIDENCE
HALLWAY CONSOLE

PAGE 1.05

